

External Hexagon | Hybrid Implants

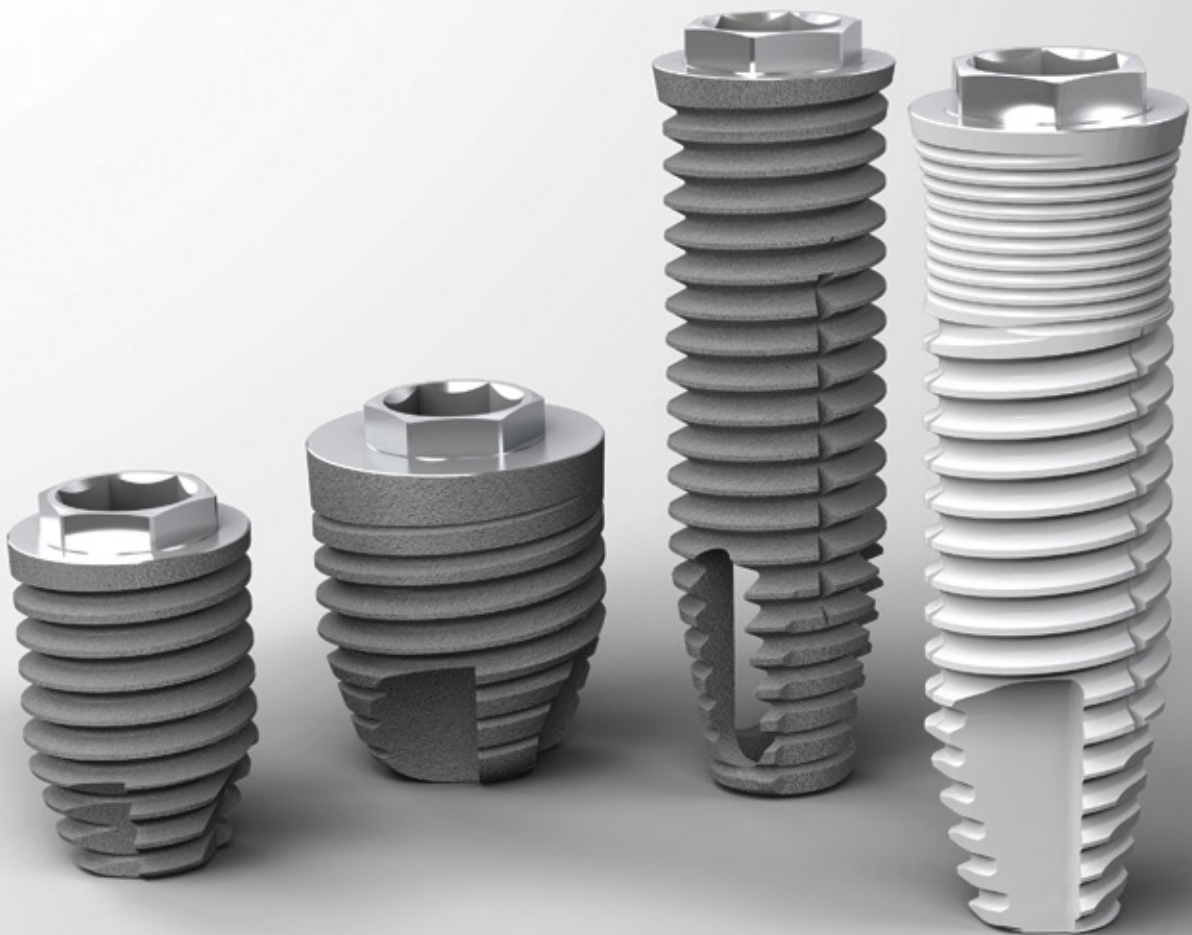

Versatility.



HEX-S | Solid

Enhanced Macrogeometry

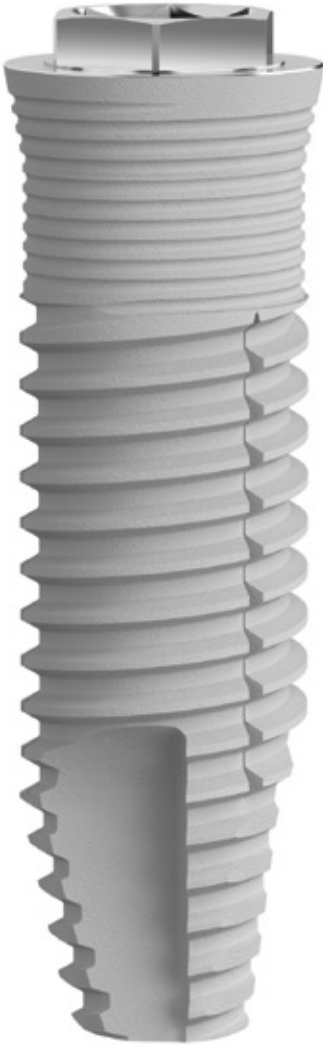

- **Easy, Safe and Simplified installation (!)**
 - . Special Conical Drills have the same geometry of Hybrid Implants
 - . Only 2-3 Conical Drills to install Ø3.75 Hybrid Implants
 - . Does not require pilot drill, counter sink or screw tap
- **High Primary Stability, Balanced**
 - . Hybrid Macro Geometry
 - . Conical Apex | Parallel Body | Slightly Conical Coronal Flange
 - . Trapezoidal cutting threads | Torque Balance
- **Cortical Preservation Potential**
 - . Presence of Micro Threads up to platform flange
 - . Better stress distribution to cortical bone
 - . Higher coronal strength
- **Maximum Bone Contact**
 - . Combination of Hybrid Implants and Conical Drills
 - . Self Tapping
 - . 2 thread entrances
 - . Conical Solid apex | 3 cutting areas



HEX | Functional

Intellectual Property and latest development of Professor P-I Brånemark

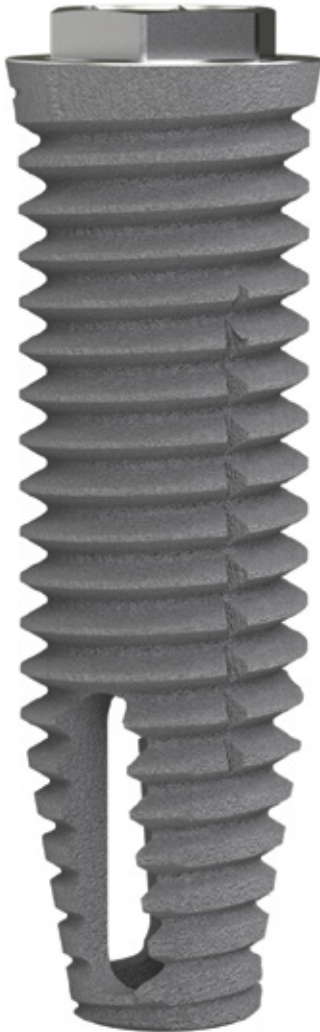

- **Easy, Safe and Simplified installation (!)**
 - . Special Conical Drills have the same geometry of Hybrid Implants
 - . Only 2-3 Conical Drills to install Ø3.75 and 4.0 Hybrid Implants
 - . Does not require pilot drill, counter sink or screw tap
- **High Primary Stability, Balanced**
 - . Hybrid Macro Geometry
 - . Conical Apex | Parallel Body | Slightly Conical Coronal Flange
 - . Rounded single threads* | Torque Balance**
- **Short Implants from 6 mm**
 - . Ø3.75, 4.0 and 5.0
 - . Apex with 4 cutting areas
 - . Recommended for partial prosthesis

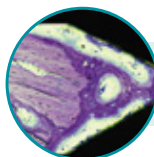

Superior interfacial neoformed bone (>BIC)



(!) See Surgical Sequence.

* Except for Ø5.0 - 2 thread entrances. ** Except HEX Ø4.0.

Interface

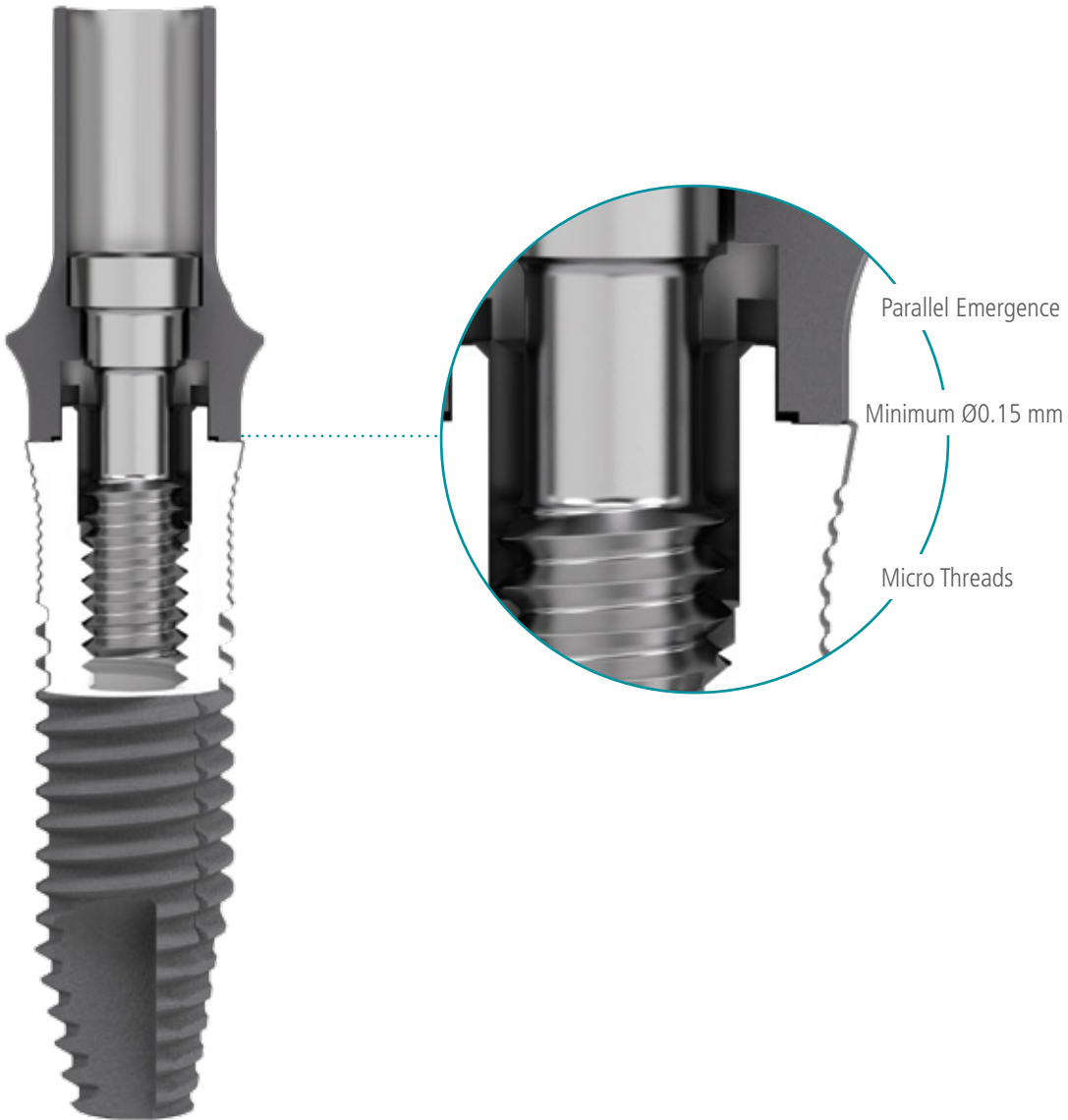

- **Increased Biological Width**

- . Parallel Emergence Components
 - . Does not require removal of cortical bone tissue

- **Platform Switching for Enhanced Tissue Preservation**

- . Platform Ø5.1 has the same Hexagon of Platform 4.1, allowing use of 4.1 Components
- . Minimum Ø0.15 mm switching in all Platform diameters | 3.5 – 4.1 – 5.1

- **Compatibility**

- . Original Platform, Hexagon and Components Dimensions for Ø4.1

- **Mountless Installation**

- . Insertion Drivers with esthetic and dimensional references
- . Same Driver for manual, handpiece and wrench installation

- **Versatile Interface**

- . Ideal for total and partial prosthesis
- . Easy prosthetic maintenance



Surfaces

P-I surfaces are modern and exhibit abundant Osseointegration properties

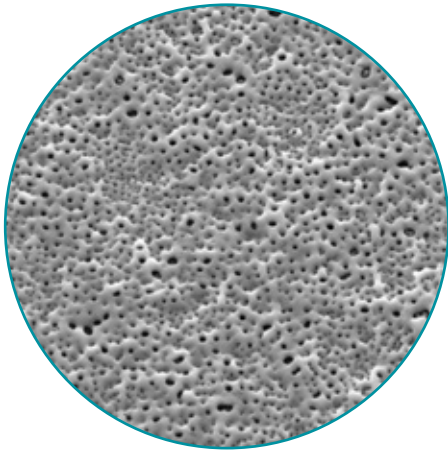

Widely Documented

- Developed in the Department of Biomaterials – University of Gothenburg - Sweden and documented in many studies by some of the most important scientists in the field of implant surfaces.

Evolution of a Modern Surface

- A patented evolution of TiUnite® featuring significantly lower micro roughness, the Ospol® Surface is oxidized and incorporates Calcium Ions (Ca^{+2}) and presents similar results when compared to moderately rough surfaces.

Better Long Term Perspective

- Ospol® Surface represents a better hypothesis of improving long term success and longevity of Implants being less prone to biofilm adhesion (Periimplantitis), in clinical use since 2004.

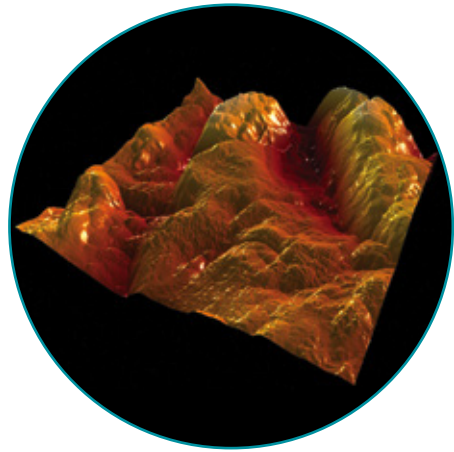

Advanced Technology

- The Micro+Nano Surface is exclusively obtained by subtraction methods, controlled microblasting and Ions bombardment technology.

Minimally Rough and Nano Structured

- Exhibiting complex minimally rough micro structures and high density of nano features, designed for efficiency during healing periods, especially early ones, the Micro+Nano Surface is documented in international studies by worldwide experts in the Osseointegration field.

New Bone Areas

- A complete solution to address a wide range of clinical cases, the Micro+Nano Surface showed slightly increased bone areas in the 3 week period when compared to Ospol® Surface.



Multiple Screw Retained | Single | Multiple Cemented Retained | Single | Multiple Screw or Cemented Retained | CAD/CAM* | Overdenture

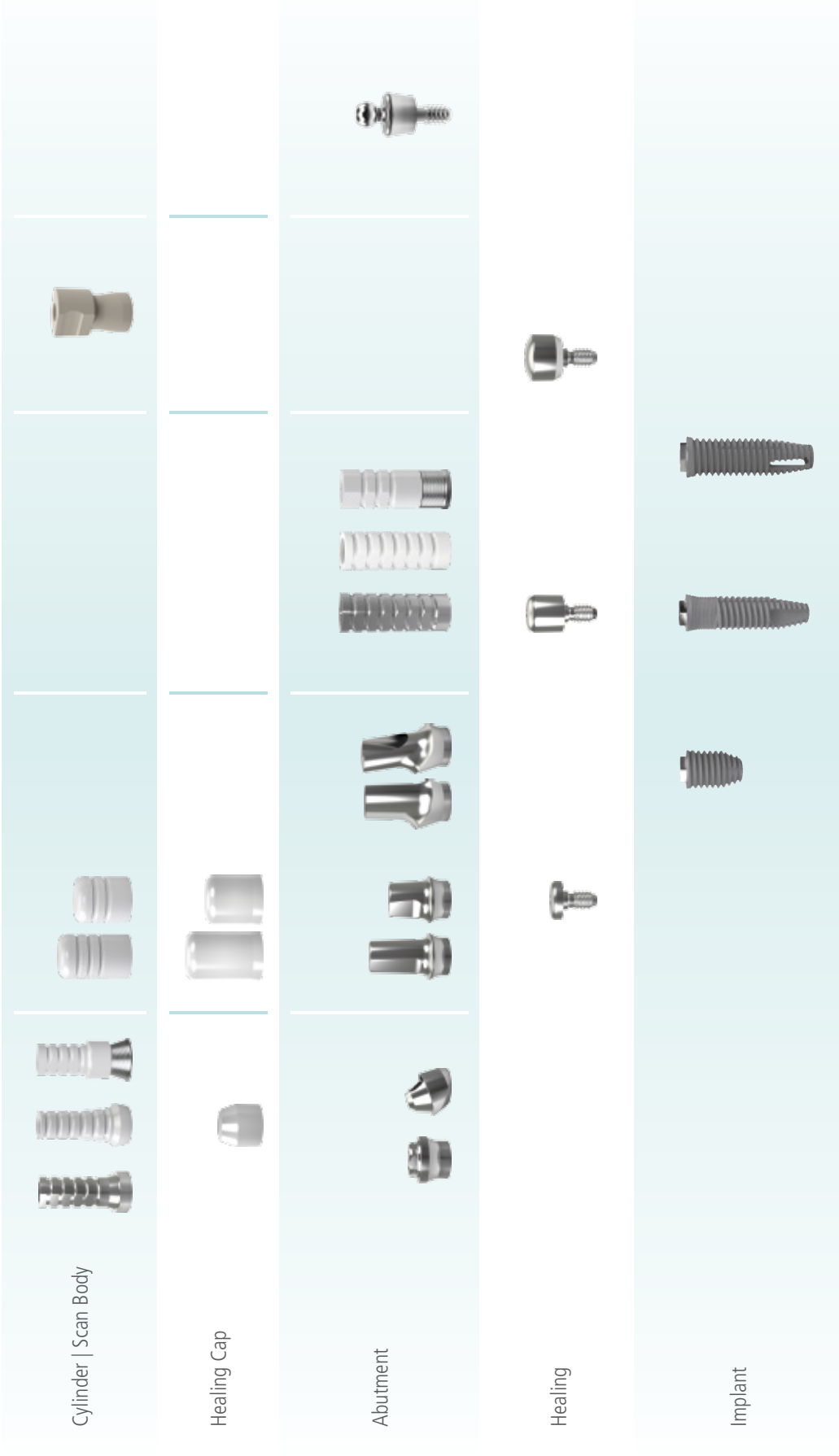

* Please refer to the CAD/CAM Solution including



Prosthetic Solutions

